



Before use, make sure the following items are included in the package. If anything is missing, contact your dealer.

Accessories: Adapter / Remote controller / SD card reader with USB interface / Bracket / cable for converting 4 endpoint, 3.5 inch headphone jack to RCA output / Quick user manual

\*A memory card is not included.

## Installation Guide

1. To install the device on the windshield by "Suction Cups" or "Stick-Holder" Type

Suction Cups Type      Sticker Adhesive Spot      Stick-Holder Type

2. The best position to install the device on the windshield

3. To adjust the recording angle properly

4. Plug in DC5V Power Supply

5. Plug in the Cigarette Charger

Best location

Cigarette adapter

(1). This device should be installed in the area where the Windshield will be able to be cleaned by windshield wiper.

(2). Formatting SD card on the PC before beginning to use.

(3). Set time zone and timing on OSD. Start the device immediately after you set time zone to make sure the video files will tally with normal time.

(4). Setting NTSC or PAL through OSD.

**Caution**

## Recording / Stop Recording

**1. Power On/Recording**  
When car power on, the device start up automatically. Please wait for 30 Sec. to start recording.

**2. Power Off/Stop recording**  
When the car power off, the device will stop to record video and sound. You can take off the memory card and insert to computer to view the video.

- (1). The display of booting screen and live view are subject to change without notice for software upgrade or re-version.
- (2). Force recording button has highest priority. Push Force recording button will pop up recording window and activate force recording immediately.
- (3). CR1220 Battery for calendar can be replaced by users.
- Caution**

## Structure of Product

1. Lens
2. Force Record
3. Cable collect slot
4. DC5V Power input
5. Video Out
6. Remote Control Receiver
7. MICRO SD Card
8. Recording Indicator
9. Power Indicator
10. Battery for permanent calendar

1. Recording indicator: Red light Blinking when recording. (Emergency recording blinking fast)

2. Power indicator: Green light is ON when power on.

## SD Card Installation

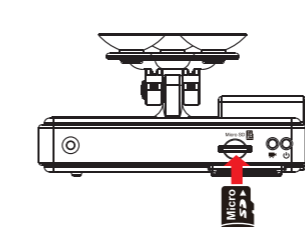

- Caution**
1. Recommend memory card class 10 or above 8GB micro SD card.
  2. Since memory cards have the writing endurance situation, we recommend to inspect the memory card and use pc for playback regularly, to ensure that the memory card can read and write
  3. Hot swap is not supported. Please power off device before remove memory card. Removing Memory Card while recording may lose or damage recorded data.

## Remote Controller

Emergency REC

Volume Down

Audio

Volume Up

Mute

Menu Enter

Navigator

Play

Stop

Pause

- ?** How to check if the remote controller is workable?
- Check the mercury cell is installed in correct direction. (Check the pole)
  - Check if the cell power is exhaust.
  - Check if the sensor is covered.
  - Check if it nears by Fluorescent Lamp.

## OSD Menu function

In Live view screen press [Menu] will popup OSD operation menu as follows:

- NTSC / PAL
- Time setting
- G-Sensor
- Microphone
- Firmware version

## Safety Precautions

Please Take and review some testing videos initially to make sure the images were recorded correctly. Please note that manufacturer, its subsidiaries and affiliates, and its distributors are not liable for consequential damages arising from any malfunction of main device accessory, including memory device that results in the failure of an image to be recorded or to be recorded in a way that is machine readable. Before using the product, please ensure that you read the safety precautions described below. Always ensure that the product is used correctly.

- Use only recommended power sources.
- Do not attempt to disassemble, alter or apply heat to the product.
- DO NOT apply multi cigarette lighter adapters-Applying such devices will cause unstable power input to damage the vehicle video recorder.
- Please always make sure all power connectors are fully secured.
- Avoid dropping or subjecting the product to severe impacts.
- To avoid the risk of injury, do not touch the interior of the product if it has been dropped or otherwise damaged.
- Stop using the product immediately if it emits smoke, a strange smell, or otherwise behaves abnormally.
- Do not use organic solvents such as alcohol, benzene, or thinner to clean the product.
- Do not let the product come into contact with water (e.g. sea water) or other liquids.
- Do not allow liquids or foreign objects to enter the VVR.
- Do not place the VVR near or in direct flame.
- Do not handle the power cord with wet hands.
- Do not use the equipment in a manner that exceeds the rated capacity of the electrical outlet or wiring accessories.
- Do not use if the power cord or plug are damaged, or not fully plugged into the outlet.
- Do not allow dirt or metal objects (such as pins or keys) to contact the terminals or plug.
- Avoid using, placing or storing the product in the humid or dusty areas.



For More Information  
Please check VACRON Website  
<http://www.vacron.com>  
Made in Taiwan  
Copyright@ FUHO Technology CO., LTD.



使用之前，請先查看包裝內所提供的下列物品。如您發現物品不齊全，請聯絡您購買的零售商。

產品配件：變壓器 / 紅外線遙控器 / USB介面SD卡讀卡機 / 支架 / 4端點3.5吋耳機座轉RCA影像輸出線材 / 簡易操作說明書

\*記憶卡並不隨機提供，請另外購買。

## 安裝示意圖

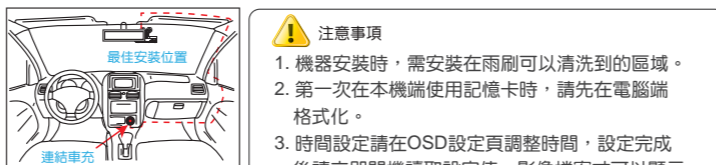
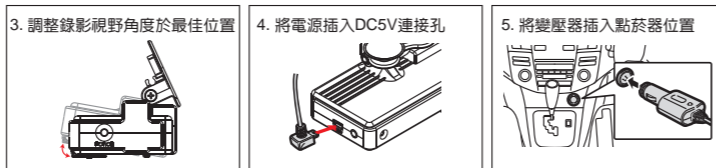
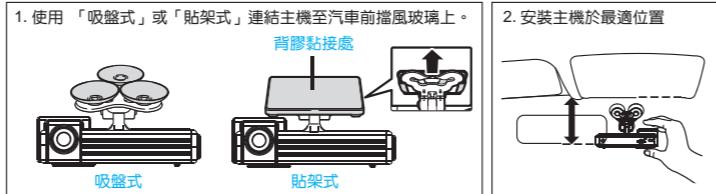

- 注意事項**
- 機器安裝時，需安裝在兩刷可以清洗到的區域。
  - 第一次在本機端使用記憶卡時，請先在電腦端格式化。
  - 時間設定請在OSD設定頁調整時間，設定完成後請立即開機讀取設定值，影像檔案才可以顯示正常時間。
  - 機器本身有區分NTSC機種或PAL機種請由OSD控制。

## 錄影及停止錄影

- 開機/錄影**  
電源啟動，並等待約30秒鐘後，即開機完成，即表示開始錄影。
- 關機/停止錄影**  
電源關閉，即為停止錄影，此時可取下記憶卡讀取所攝錄之檔案

- 注意事項**
- 開機畫面與即時檢視畫面呈現方式，可能因軟體更新或改版而有所改變，恕不另行通知。
  - 強制錄影鍵有強制性，在任何狀態下觸發強制錄影鍵皆會跳回錄影畫面啟動強制錄影。
  - 萬年曆時鐘電池CR1220若沒電時，使用者可自行更換。

## 產品外觀

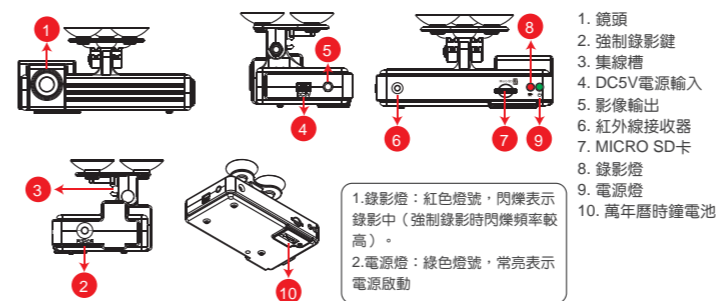

## 記憶卡安裝

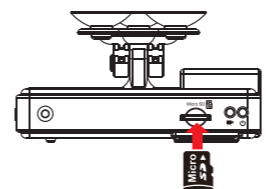

- 注意事項**
- 建議使用 Class10 8G 以上 Micro SD Card 記憶卡。
  - 記憶卡有讀寫次數與壽命問題，建議定期檢查與使用電腦播放影像，確保記憶卡仍可正常讀寫。
  - 本產品不支援記憶卡熱插拔，插拔卡前請先斷電。錄影中將記憶卡強制取出可能造成資料毀損問題。

## 遙控器

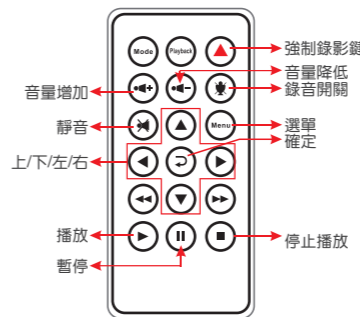

- 遙控器異常檢查**
- ☑ 檢查電池的正負極性
  - ☑ 檢查電池電量是否用完
  - ☑ 檢查遙控感測器是否被遮住
  - ☑ 檢查附近是否有螢光燈正在使用

## OSD選單



## 安全注意事項

請先試錄影片，然後播放，以確定機器操作正常。請注意，如因本機配件，包括記憶卡的故障，導致不能拍攝影像或不能讀取影像格式而引起的任何損失，本公司、其附屬機構及經銷商皆不負責任。

使用本產品之前，請確定您已閱讀下列的安全注意事項。並請確定您操作產品的方法是正確的。

- 請存放本器材於兒童與嬰兒無法觸碰的地方。
- 請只使用建議的電源。
- 請勿使用外接式(多孔)點菸器，避免因點菸器電壓不穩導致產品當機、失去電力而無法錄影。
- 點菸頭電源與本產品電源頭，請「務必」密合緊實。
- 請勿嘗試將產品拆開、改裝或加熱。
- 避免使產品丟落地上或受猛烈撞擊。
- 要避免受傷，請勿在產品跌下後或損毀時觸碰產品的內部。
- 如產品冒煙、發出異味或有其他異常，請立刻停止操作產品。
- 請勿使用有機溶劑，如酒精、苯或油漆稀釋劑清潔產品。
- 請勿讓產品接觸到水（如海水）或其他液體。
- 請勿讓任何液體或異物進入機器。
- 請避免端子或插頭接觸到金屬物件（如針或鑰匙）或污漬。
- 請避免在潮濕或多塵的地方使用、放置或存放產品。



更多產品資訊，請上VACRON車用官網  
<http://vvr.vacron.com.tw>

製造產地：台灣  
馥鴻科技股份有限公司